







 Ø6,3x50 mm A1 x 42	 Ø12 mm A2 x 42	 4 mm A3 x 1	 Ø15x12 mm B1 x 12	 Ø5x44 mm B2 x 12
 Ø20 mm B3 x 12	 Ø12x3 mm C x 4	 Ø4x16 mm D1 x 48	 Ø4x20 mm D2 x 4	 Ø1,6x25 mm F x 148
 Ø8x36 mm G x 36	 K x 4	 N x 4	 417 mm O1 x 1	 345 mm O2 x 1

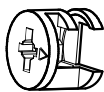
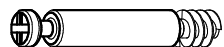

Box 1/2

873x345x3 mm

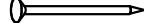
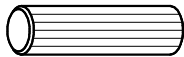
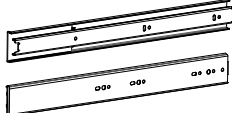

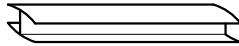
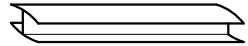
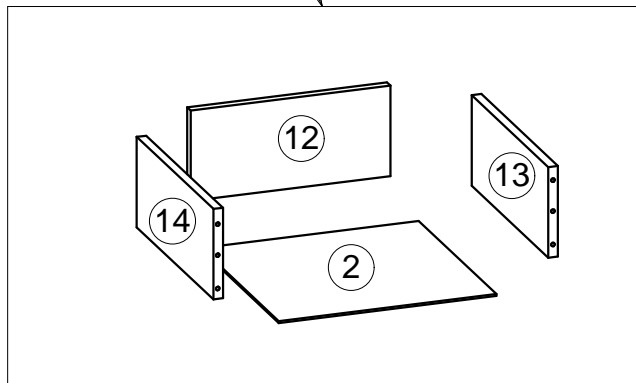
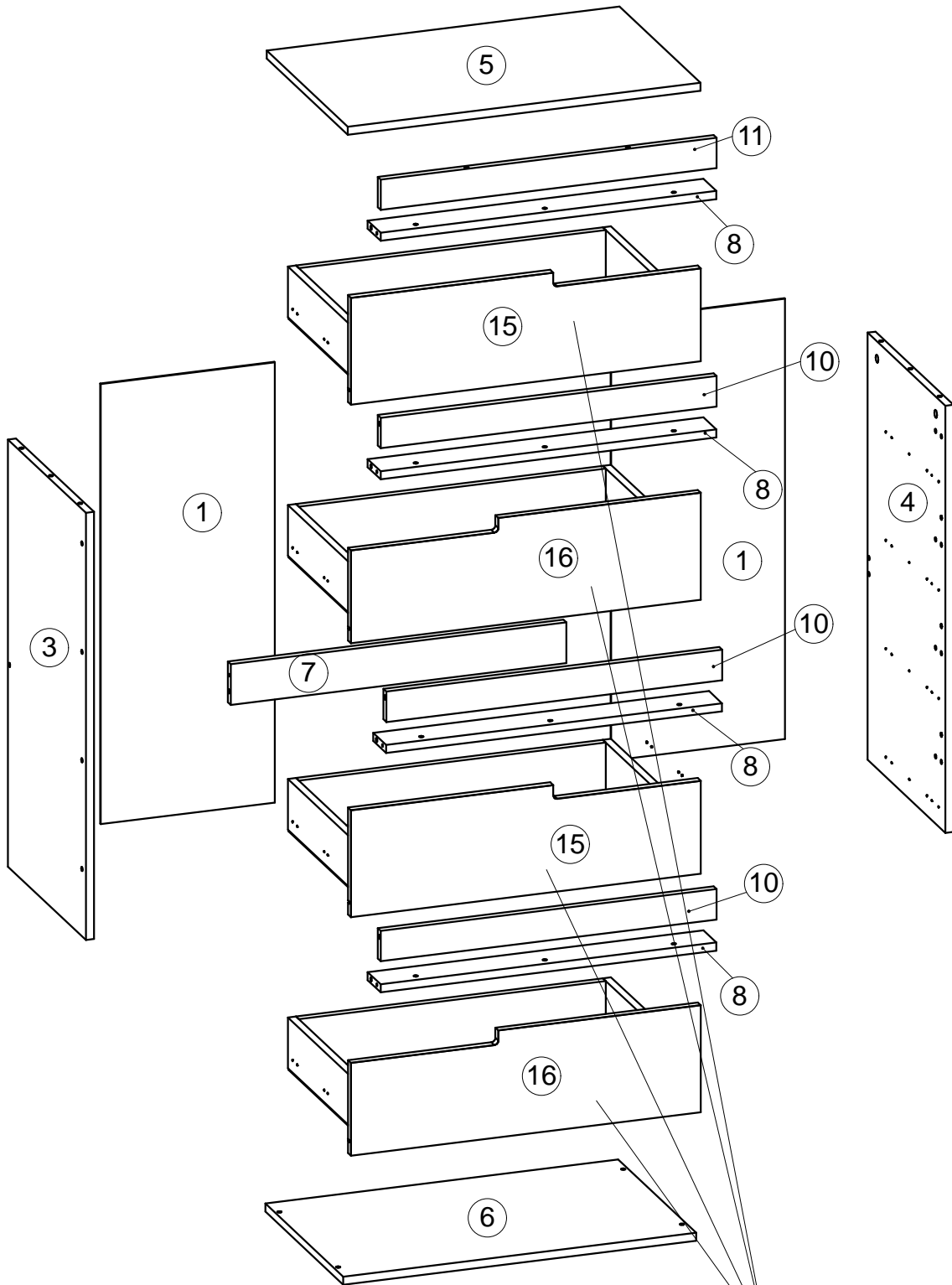
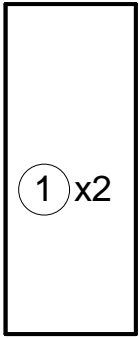
639x406x3 mm

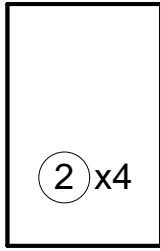

847x424x16 mm

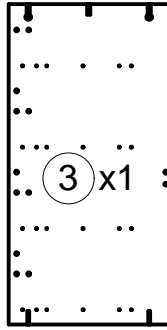

847x424x16 mm

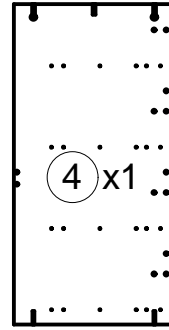

666x80x16 mm

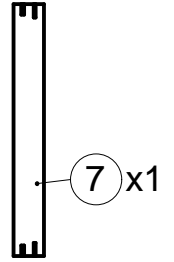

666x70x16 mm

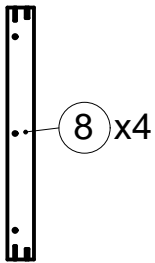

666x60x16 mm

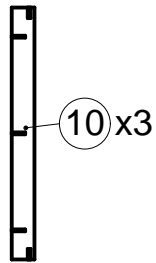

666x60x16 mm

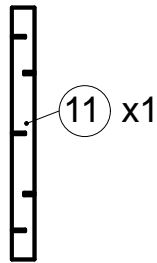

609x100x16 mm

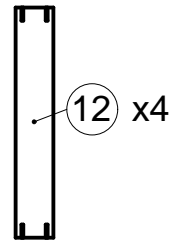

400x100x16 mm

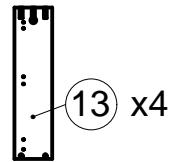

400x100x16 mm

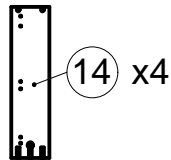

Fittings & Tools

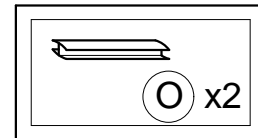

Box 2/2

699x441x16 mm

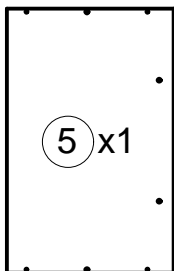

699x424x16 mm

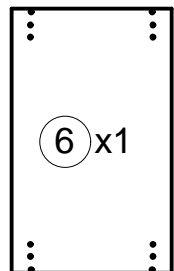

698x216x16 mm

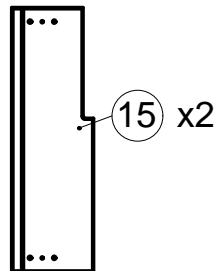

698x216x16 mm

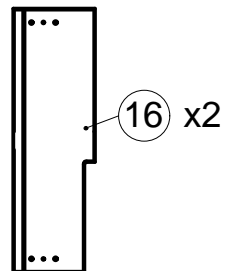

1

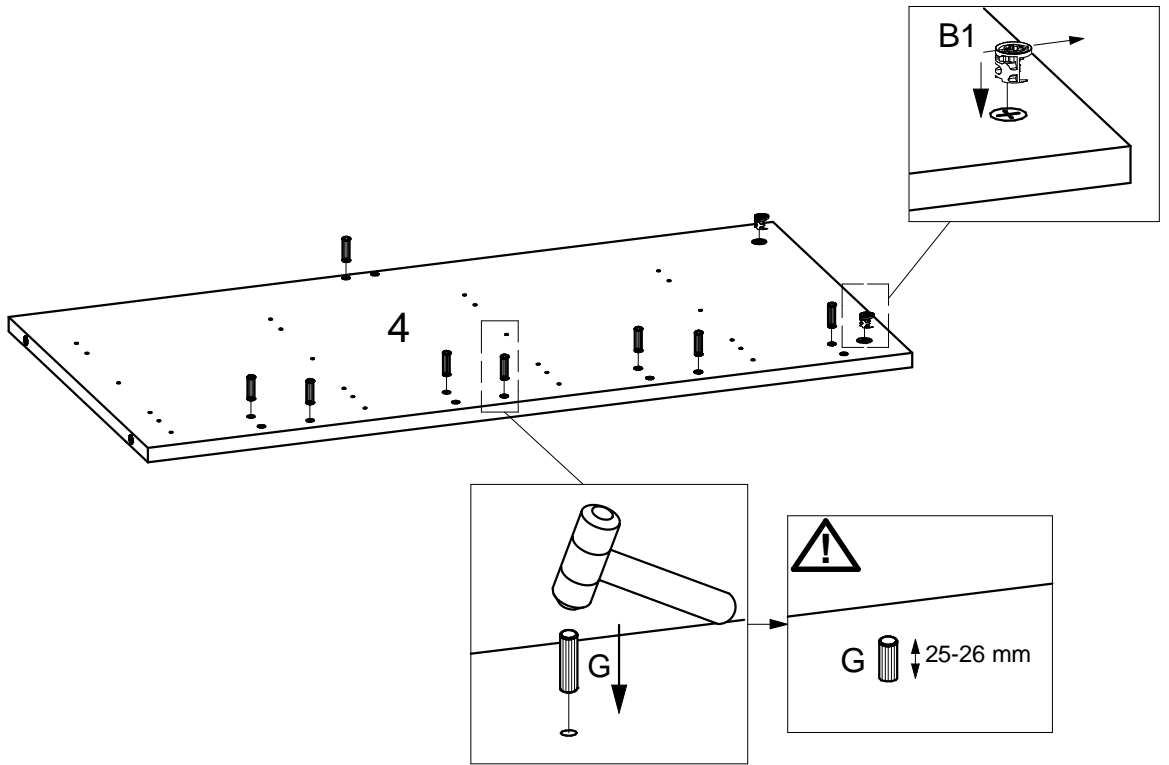
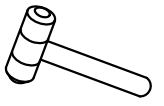
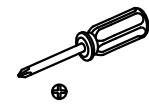
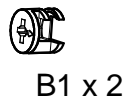
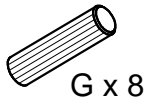

2

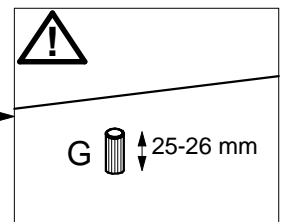
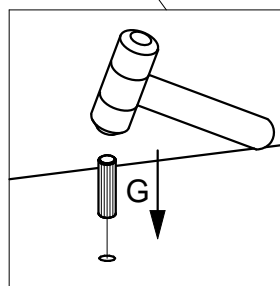
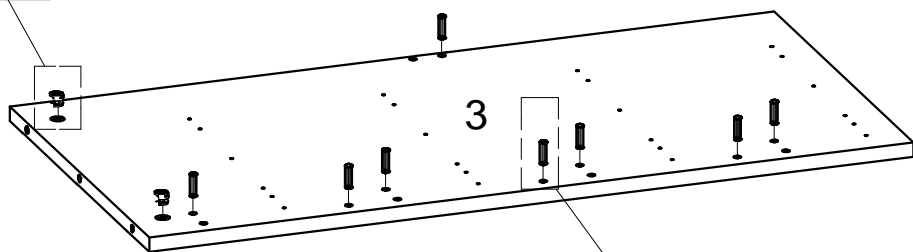
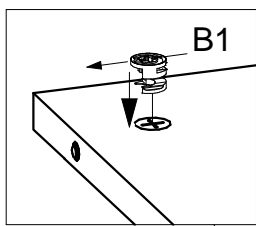
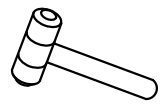
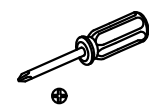
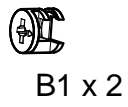
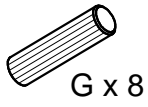

3

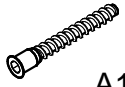

A1 x 3



A2 x 3



A3 x 1

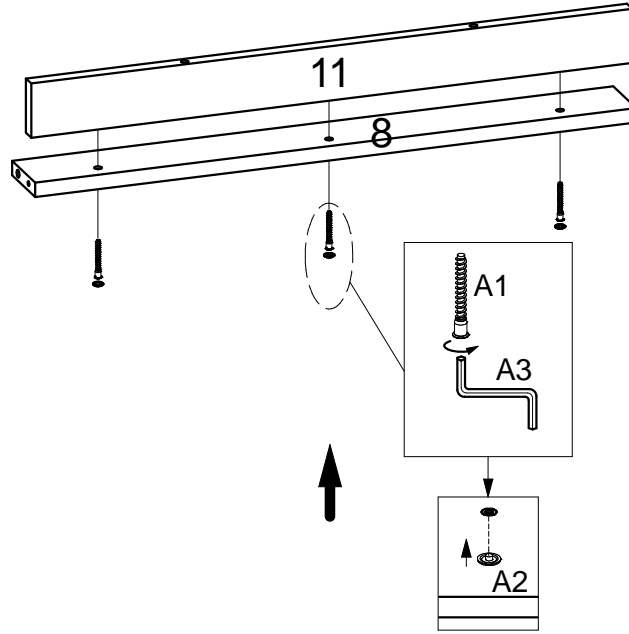

4

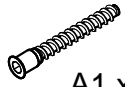

A1 x 9



A2 x 9



A3 x 1

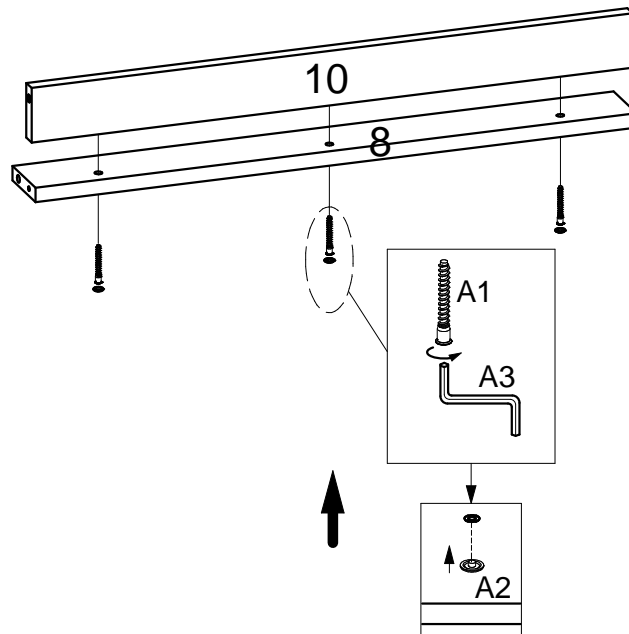

x 3

5

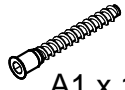

A1 x 10



A2 x 10



A3 x 1

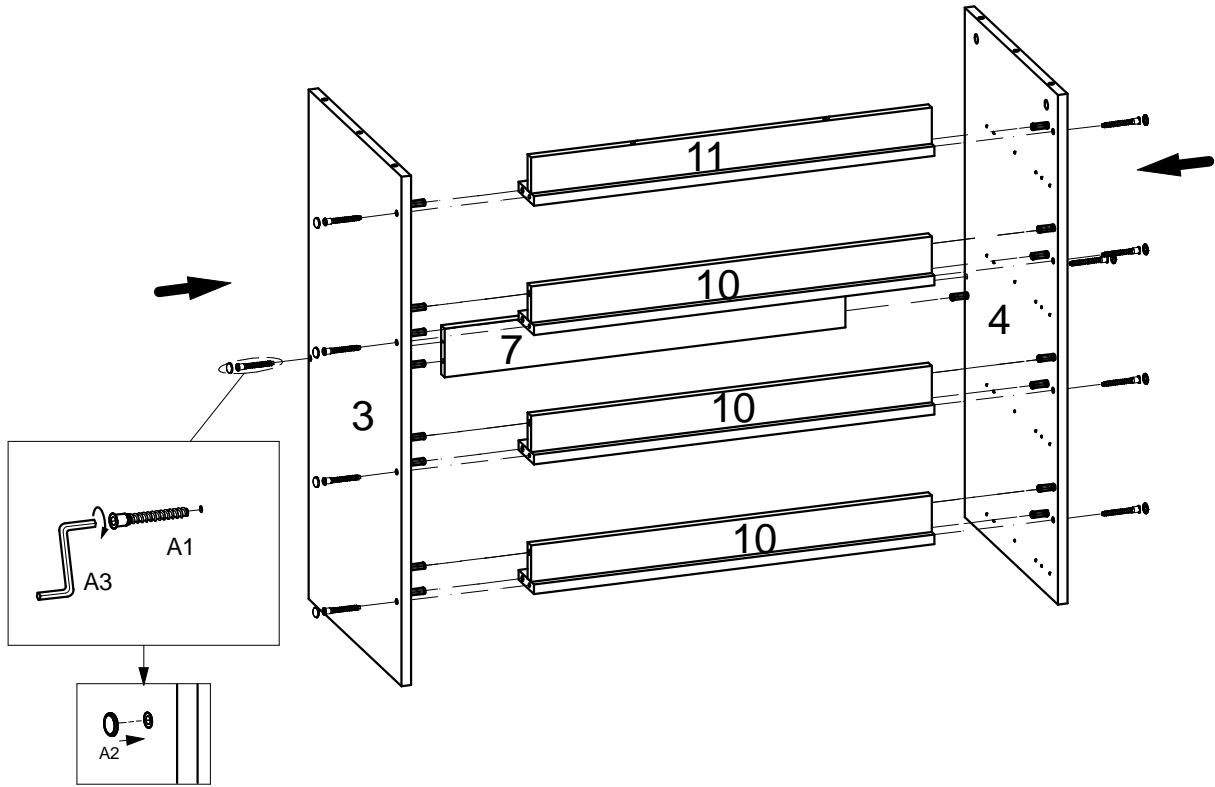

6

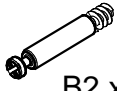

B2 x 4



G x 4

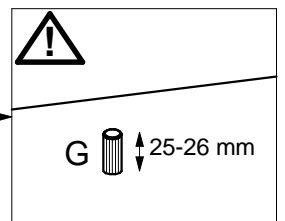
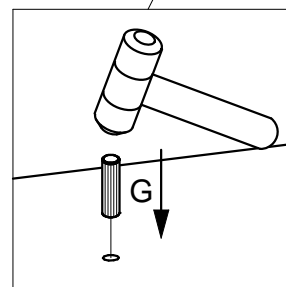
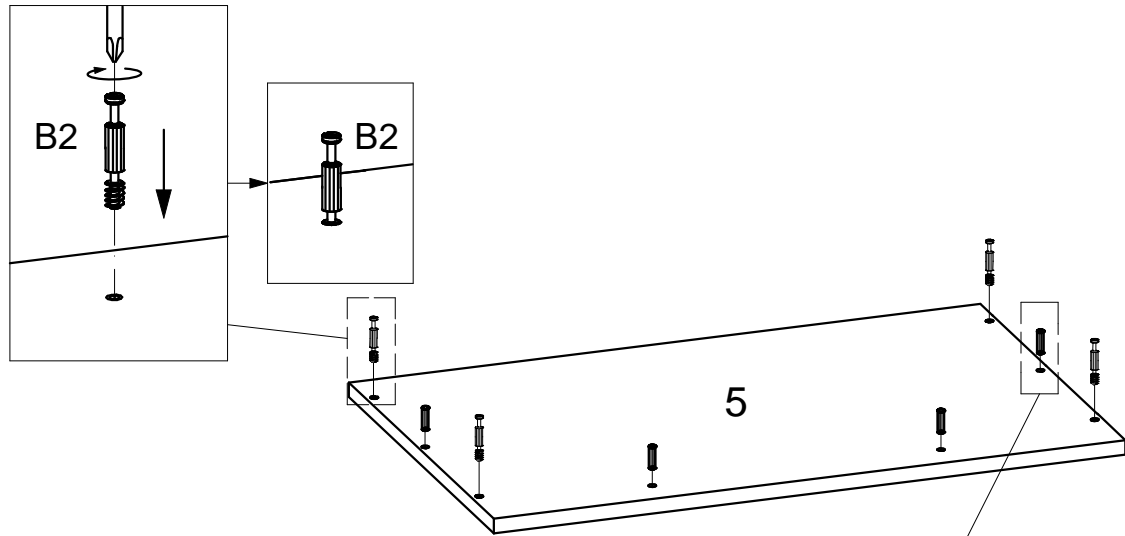
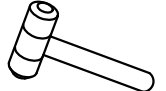
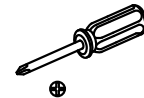

7

A1 x 4

A2 x 4

A3 x 1

B3 x 4

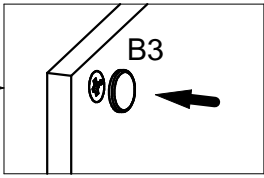
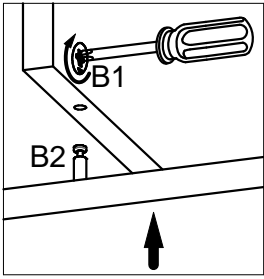
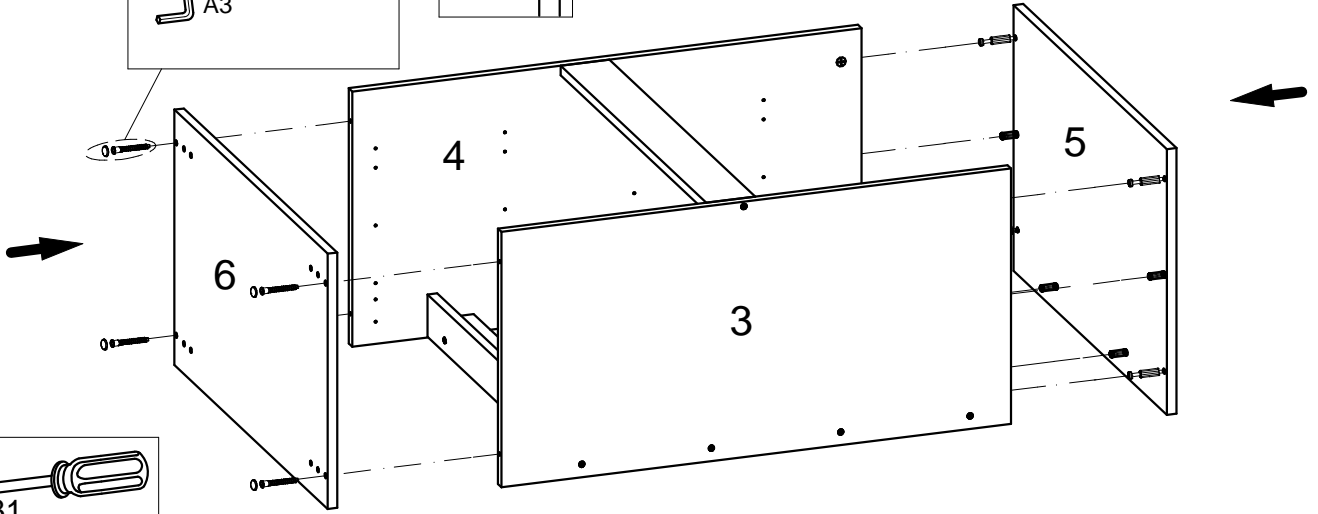
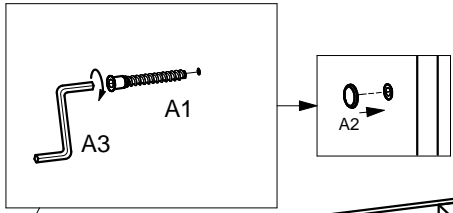
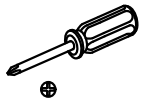
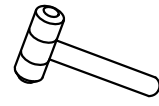

8

C x 4

D2 x 4

F x 60

N x 4

O1 x 1

O2 x 1

⚠ XX=YY≅90°

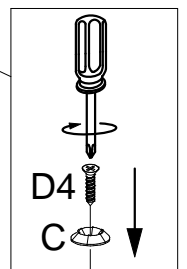
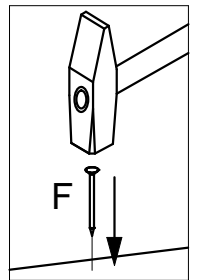
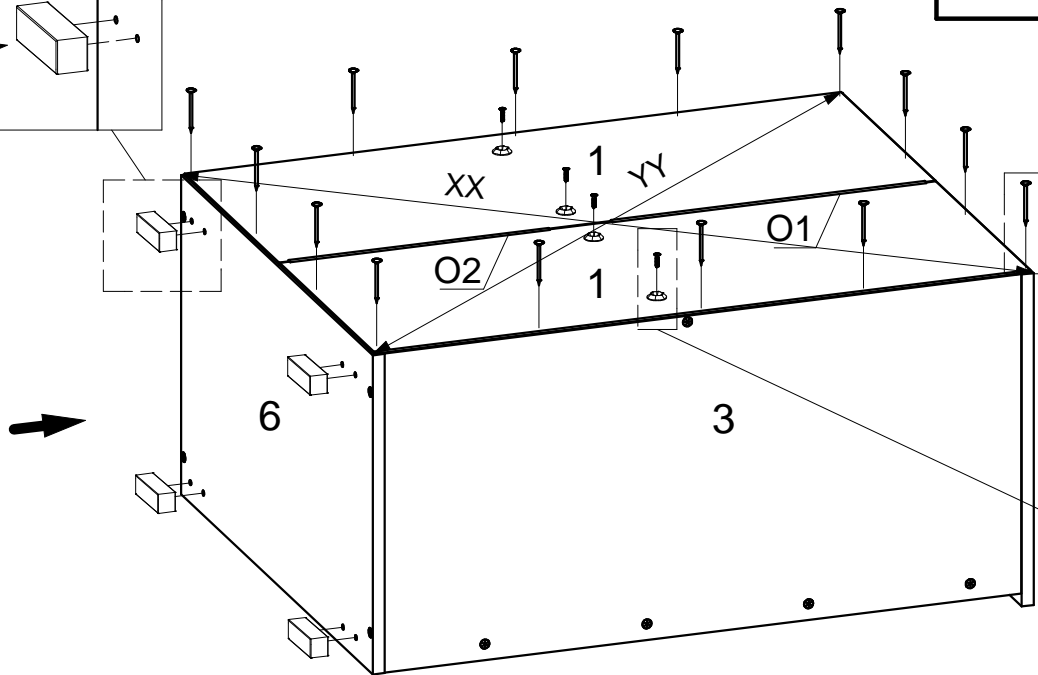
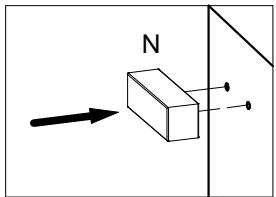
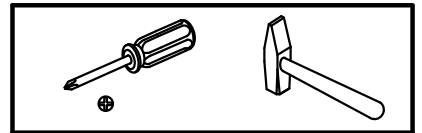

9



D1 x 24



K.1 x 4



K.2 x 4

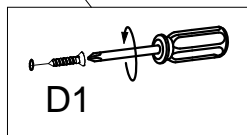
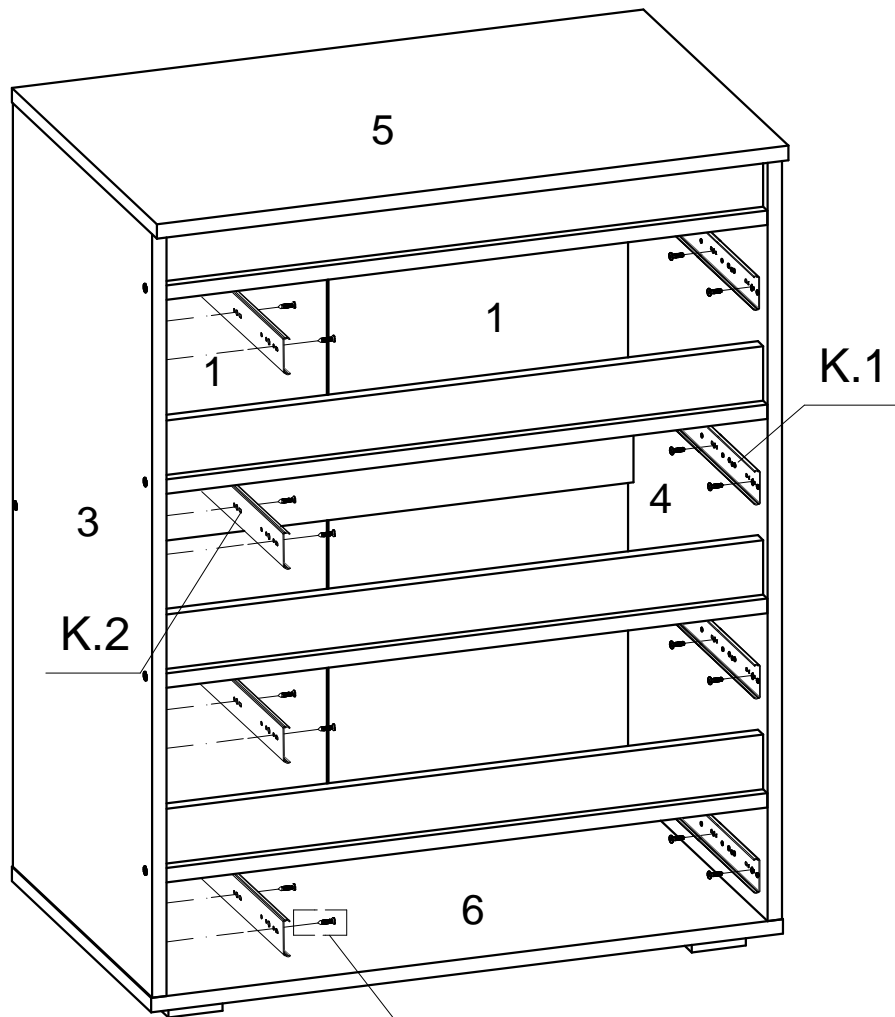
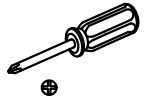

D1

10

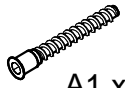

A1 x 16



A2 x 16



A3 x 1



B1 x 8

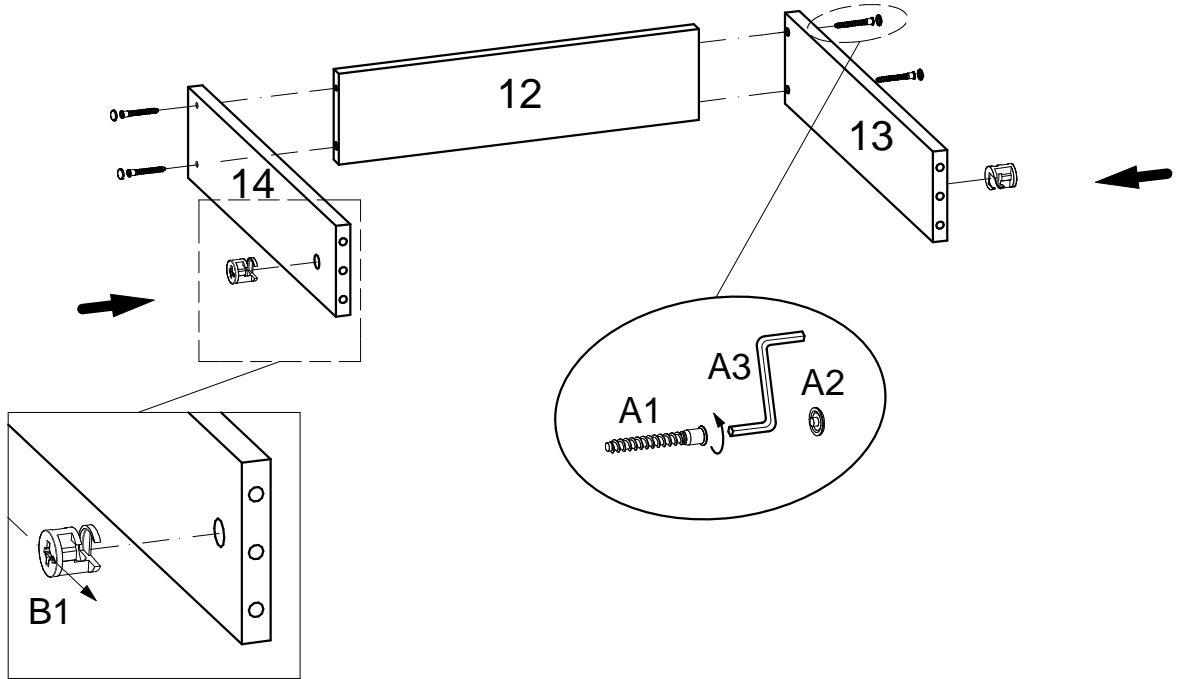

x 4

11

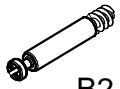

B2 x 4



B3 x 4



G x 8

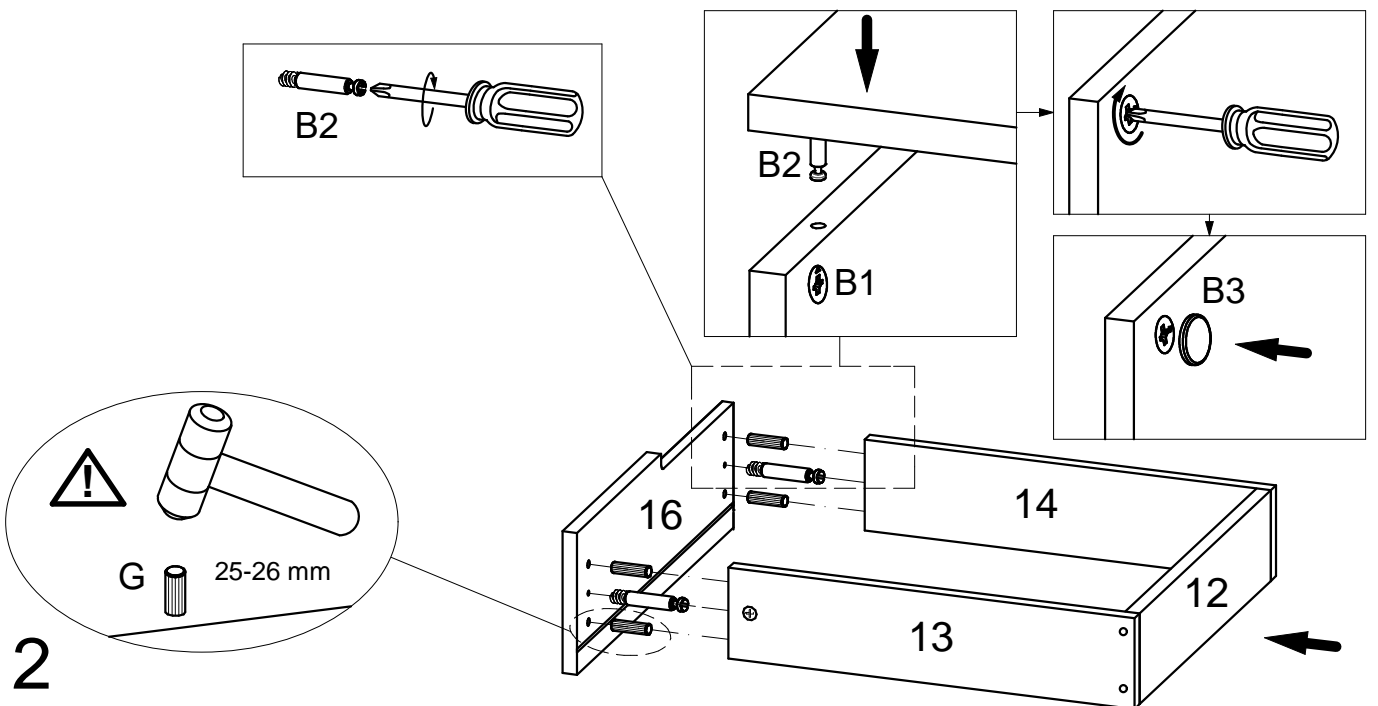
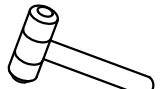
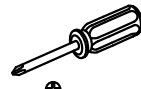

x 2

12

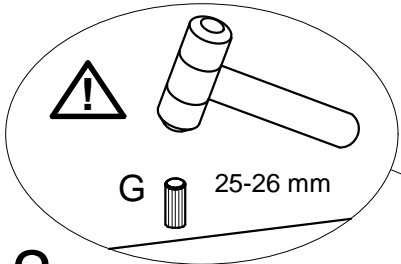
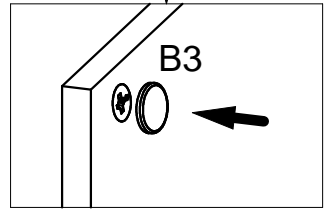
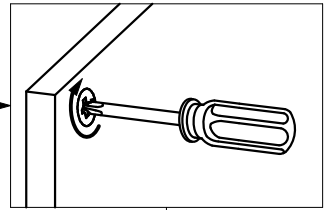
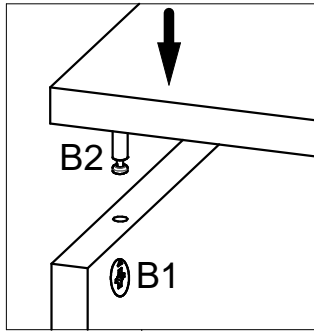
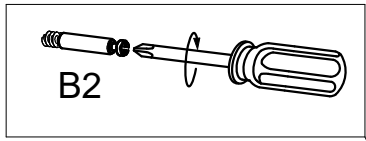
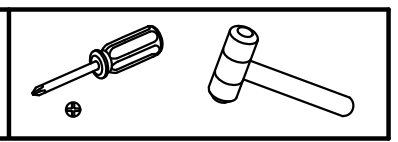
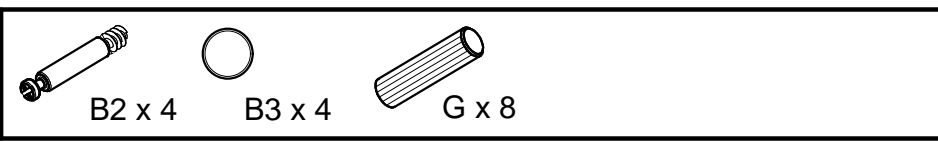

x 2

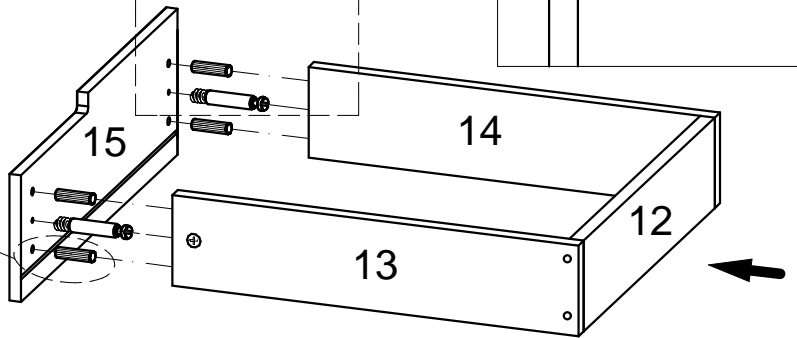

13

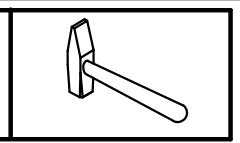

! $XX=YY \cong 90^\circ$

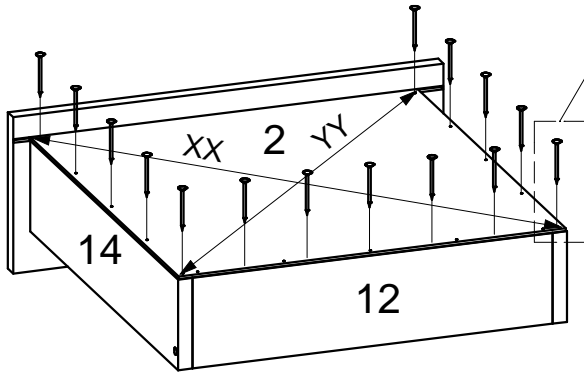
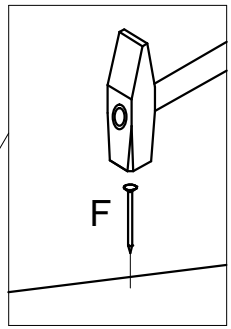

x 2

14



D1 x 12



K.3 x 2



K.4 x 2

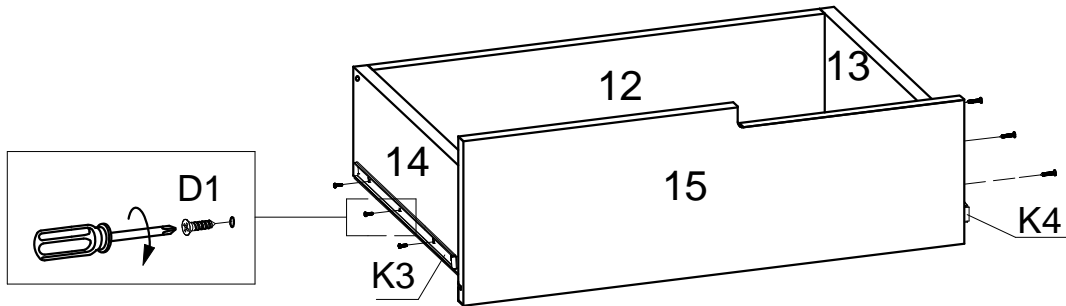
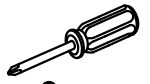

x 2

15



D1 x 12

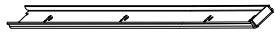

K.3 x 2



K.4 x 2

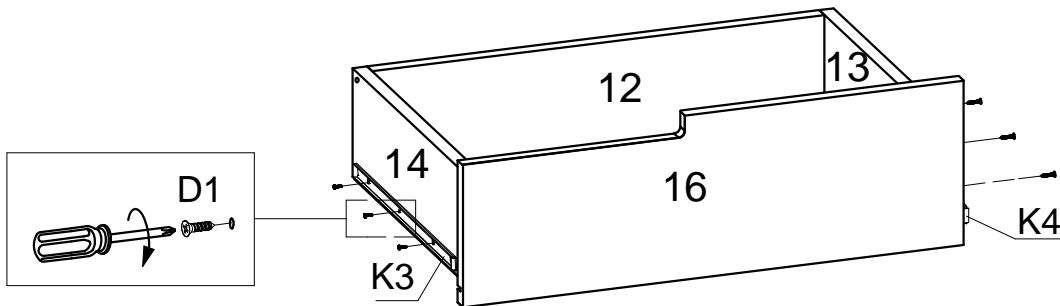
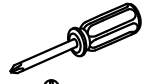

x 2

16

